

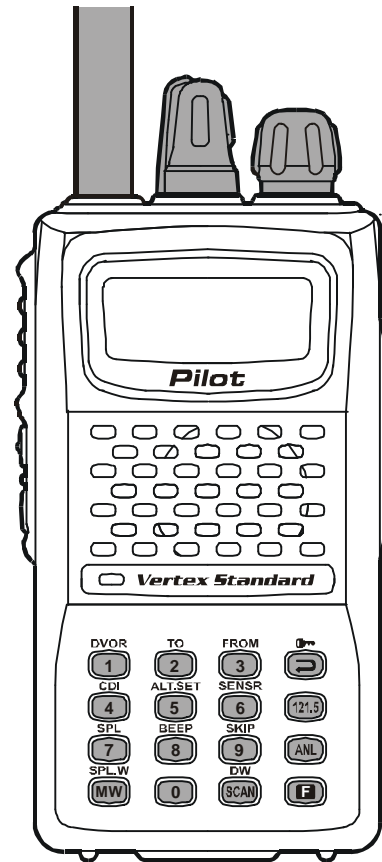

AIR BAND TRANSCEIVER

Pilot Operating Manual

VXA-210



CONTENTS

Important Notice!	1	Barometric Pressure/Altitude Metering	22
Introduction	2	Thermometer Calibration	22
Controls & Connectors	3	Correcting the Atmospheric Pressure Meter (Barometer Offset) ..	23
Top Panel	3	Correcting the Altimeter setting (Altimeter Offset)	23
Front Panel	4	How to Measure the Barometric Pressure or Altitude	24
LCD Display	5	Weather Sensor Mode	24
Keypad	6	Memory Operation	26
Left Side	7	Memory Storage	26
Right Side	8	Recalling the Memories	27
Before You Begin	9	Scanning Operation	28
Precaution	9	Channel-Skip Scanning	29
Battery Installation and Removal	9	Dual Watch Operation	30
Battery Charging	10	Priority Dual Watch Operation	31
Low Battery Indication	11	VOR Navigation	32
Installing the FBA-25 (option) Alkaline Battery Case ..	11	To Select the DVOR Mode	33
Operation	12	Flying to a VOR Station	34
Preliminary Steps	12	Entering a Desired Course	36
Operation Quick Start	12	Position Cross-checking	37
Squelch Adjustment	14	Split Operation	38
Accessing the 121.5 MHz Emergency Frequency	14	Field Programming Mode	39
Tuning Methods	15	Memory Storage into the Book Memory	39
Transmission	16	Menu ("Set") Mode	40
Reception of Weather Channel Broadcasts	16	Menu Listing	41
Monitor Key	18	Installation of the SU-1	45
ANL (Automatic Noise Limiter) Feature	18	Accessories & Options	46
Temperature Display	19	Specifications	48
LOCK Function	19		
Receive Battery Saver Setup	20		
Beep On/Off	21		

NOTICE

There are no user-serviceable points inside this transceiver. All service jobs must be referred to your Authorized Service Center.

IMPORTANT NOTICE!

FCC RF Exposure Compliance Requirements for Occupational Use Only:

This Radio has been tested and complies with the Federal Communications Commission (FCC) RF exposure limits for Occupational Use/Controlled exposure environment. In addition, it complies with the following Standards and Guidelines:

- ❑ FCC 96-326, Guidelines for Evaluating the Environmental Effects of Radio-Frequency Radiation.
- ❑ FCC OET Bulletin 65 Edition 97-01 (1997) Supplement C, Evaluating Compliance with FCC Guidelines for Human Exposure to Radio Frequency Electromagnetic Fields.
- ❑ ANSI/IEEE C95.1-1992, IEEE Standard for Safety Levels with Respect to Human Exposure to Radio Frequency Electromagnetic Fields, 3 kHz to 300 GHz.
- ❑ ANSI/IEEE C95.3-1992, IEEE Recommended Practice for the Measurement of Potentially Hazardous Electromagnetic Fields - RF and Microwave.
- **This radio is NOT approved for use by the general population in an uncontrolled environment. This radio is restricted to occupational use, work related operations only where the radio operator must have the knowledge to control its RF exposure conditions.**
- **When transmitting, hold the radio in a vertical position with its microphone 1 to 2 inches (2.5 to 5 cm) away from your mouth and keep the antenna at least 1 inch (2.5 cm) away from your head and body.**
- **The radio must be used with a maximum operating duty cycle not exceeding 50%, in typical Push-to-Talk configurations.**
DO NOT transmit for more than 50% of total radio use time (50% duty cycle). Transmitting more than 50% of the time can cause FCC RF exposure compliance requirements to be exceeded.
The radio is transmitting when the red LED on the top of the radio is illuminated. You can cause the radio to transmit by pressing the P-T-T button.
- Always use Vertex Standard authorized accessories.

INTRODUCTION

The Vertex Standard **VXA-210 Pilot** is a compact, stylish, solid hand-held transceiver providing communication (transmit and receive) capability on the International Aircraft Communication Band (“COM” band: 118 ~ 136.975 MHz), and it additionally provides VOR and CDI navigation features on the “NAV” band (108 ~ 117.975 MHz).

The **VXA-210** includes Temperature display with our exclusive Omni-Glow™ display back-light for minimal degradation of your night vision, NOAA weather band monitoring, 8-character Alpha/Numeric Display, 50 Memory Channels, and 100 “Book Memory” Channels. And the optional Barometric Pressure Unit (**SU-1**) provides readout of barometric pressure, altitude, and density altitude.

We recommend that you read this manual in its entirety, so as to understand the many features of the **VXA-210** completely. Keep this manual handy, so you may use it for reference.

NOTE: The **VXA-210**'s VOR and CDI Navigation features are supplemental aids to navigation only, and are not intended to be a substitute for accurate (primary) VOR/CDI or landing service equipment. And also, the Barometric/Altitude features of the optional **SU-1** are not designed to be a substitute for accurate, calibrated Barometer or Altimeter devices used for navigation critical to personal safety.

Congratulations!

You now have at your fingertips a valuable communications tool—a Vertex Standard two-way radio! Rugged, reliable and easy to use, your Vertex Standard radio will keep you in constant touch with your colleagues for years to come, with negligible maintenance down-time.

Please take a few minutes to read this manual carefully. The information presented here will allow you to derive maximum performance from your radio, in case questions arise later on.

We're glad you joined the Vertex Standard team. Call on us anytime, because communications is our business. Let us help you get your message across.

CONTROLS & CONNECTORS (TOP PANEL)

① Antenna Jack

This SMA jack accepts the supplied flexible antenna, or another antenna designed to provide 50 Ω impedance on the Aircraft Communication Band.

② POWER/VOLUME Knob

Turn this control clockwise to turn the radio on and to increase the volume. Counterclockwise rotation into the click-stop will turn the radio off.

③ BUSY/TX Indicator Lamp

This lamp glows **green** when a signal is being received and **red** when transmitting.

④ DIAL Selector Knob

This 20-position detented rotary switch tunes the operating frequency or selects the memory channels.

Pressing this knob downward momentarily selects the tuning methods among the **VFO** (Variable Frequency Oscillator), **MR** (Memory Recall), **BOOK** (Pre-Programmed Memories), and **WX** (Weather Channel Memories) mode.

Note: The **WX** mode is available in the USA version only.

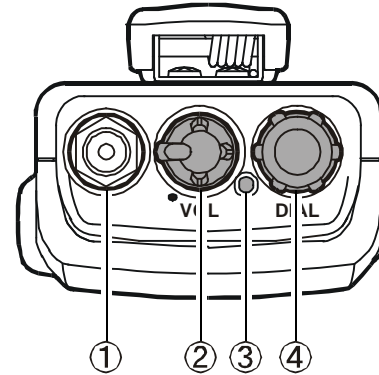

CONTROLS & CONNECTORS (FRONT PANEL)

⑤ LCD (Liquid Crystal Display)

The display shows the selected operating conditions as indicated on the next page.

⑥ Loudspeaker

The internal speaker is located in this position.

⑦ Microphone

Speak across this opening in a normal voice level while pressing the **PTT** switch, to transmit.

⑧ Keypad

Several keys have dual functions.

The *primary* functions are labeled on the key top (activated by simply pressing the key momentarily), while the *secondary* functions are labeled in yellow above the top edge of the key (activated by pressing the **[F]** key first, then the indicated key).

These functions are described in detail on page 6.

⑨ Battery Pack Latch



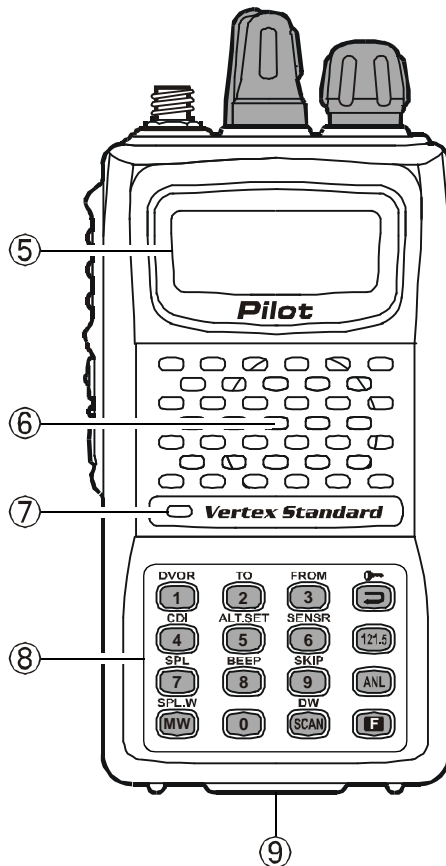



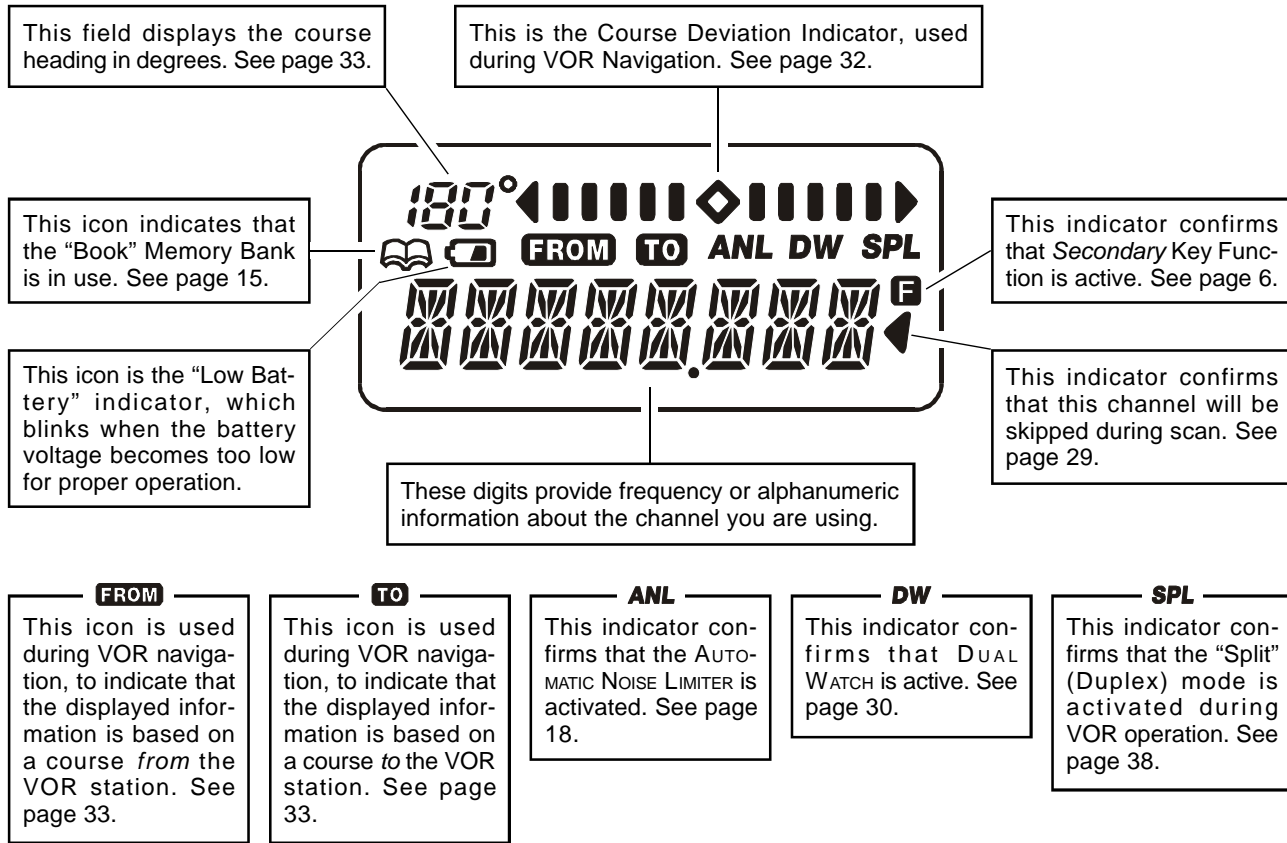













Open this latch for battery removal.



CONTROLS & CONNECTORS (LCD DISPLAY)



CONTROLS & CONNECTORS (KEYPAD)

	DVOR 	TO 	FROM 	
Primary Function (Press Key)	Frequency Entry Digit 1	Frequency Entry Digit 2	Frequency Entry Digit 3	Selects Memory Display Type (page 27)
Secondary Function (Press  +)	Activates DVOR mode	Selects "TO" VOR mode	Selects "FROM" VOR mode	Locks the Keypad
	CDI 	ALT.SET 	SENSR 	
Primary Function (Press Key)	Frequency Entry Digit 4	Frequency Entry Digit 5	Frequency Entry Digit 6	Selects Emergency Channel (121.5 MHz)
Secondary Function (Press  +)	Activates Course Deviation Indicator mode	Activates the Altimeter Set function	Activates the Sensor Functions	None
	SPL 	BEEP 	SKIP 	
Primary Function (Press Key)	Frequency Entry Digit 7	Frequency Entry Digit 8	Frequency Entry Digit 9	Activates Automatic Noise Limiter
Secondary Function (Press  +)	Activates Split (Duplex) mode	On/Off Switch for Keypad Beeper (page 21)	Allows Skipping of Channel during Scan	None
	SPL.W 		DW 	
Primary Function (Press Key)	Memory "Write" Command	Frequency Entry Digit 0	Activates Scanning	Activates "Secondary" Key mode
Secondary Function (Press  +)	Split-Memory "Write" Command	None	Activates Dual Watch	None

CONTROLS & CONNECTORS (LEFT SIDE)

⑩ PTT (PUSH TO TALK) Switch

Press this button to transmit when you are operating in the **COM** band. Release this button to return to the “RECEIVE” mode. See page 16.

⑪ MONITOR Switch

This button may be pressed to “open” the squelch manually, allowing you to listen for very weak signals. Press and hold this button for 2 seconds to “open” the squelch continuously. Press this button again to resume normal (quiet) monitoring. See page 18.

⑫ LAMP Switch

Pressing the **LAMP** switch momentarily will illuminate the display and keypad for five seconds, after which the back-lighting will automatically turn off. Press and hold this switch for 2 seconds to activate the back-lighting lamp continuously. To turn the lamp off, press this switch again. The **LAMP** switch may be configured in several ways via the Menu; see page 43 for details.

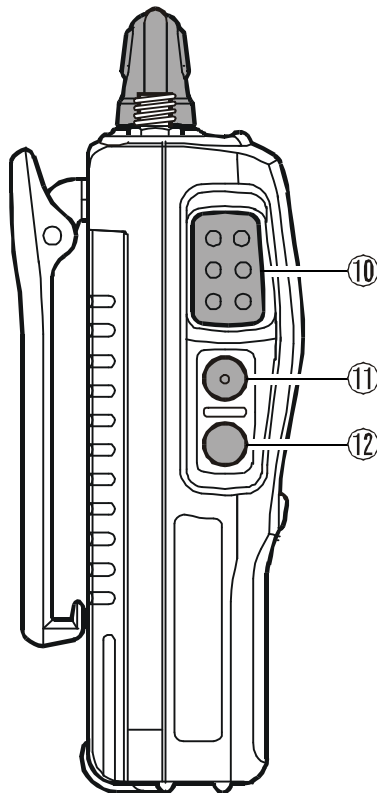

CONTROLS & CONNECTORS (RIGHT SIDE)

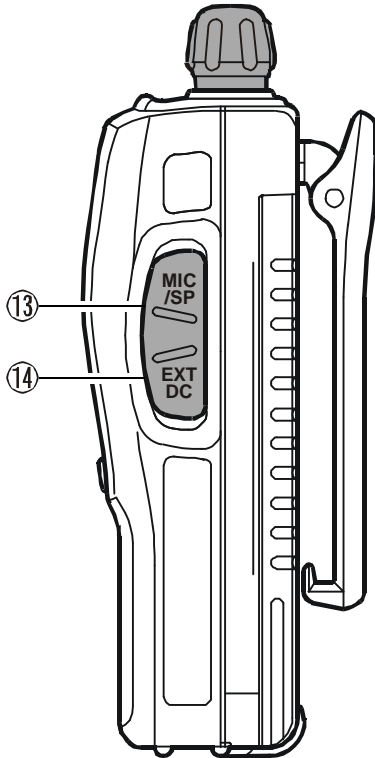

⑬ MIC/EAR Jack

You may connect the supplied **CT-60** Headset Cable or the (optional) **MH-44A4B** Speaker/Microphone to this jack.



Never connect any Speaker/Microphone that is not recommended by the manufacturer. Because these jack connections are unique, using a Speaker/Microphone that is not specified by Vertex Standard may damage the VXA-210.

⑭ EXT DC Jack

When an external 12-Volt DC power source is available, you may connect the (optional) **E-DC-5B** External DC Cable here. *Do not connect any wire to this jack if that wire is connected directly to a 28-Volt DC source.* Connecting the **VXA-210** directly to a source which exceeds 15.0 Volts DC will result in damage to the unit.

BEFORE YOU BEGIN

Precautions

- ❑ This apparatus is capable of two-way communication on channels used for critical aviation safety communications. Therefore, it is important that this radio be kept away from children or other unauthorized users at all times.
- ❑ When making DC connections via the (optional) **E-DC-5B** DC cable, be absolutely certain to observe the proper voltage level and polarity guidelines. Do not connect this radio directly to any 24 ~ 28 Volt DC source, nor to AC power of any kind. Connecting the **VXA-210** directly to a source which exceeds 15.0 Volts DC will result in damage to the unit.
- ❑ Do not dispose of the Ni-Cd Battery Pack in a fire. Do not carry a Ni-Cd Battery Pack in your pocket, where keys or coins could short the terminals. This could create a serious fire/burn danger, and possibly cause damage to the Ni-Cd pack.
- ❑ Although the **VXA-210** is designed to be water resistant, the enclosure is not “waterproof.” Do not allow the radio to become submersed in water, and do not expose it and/or its Ni-Cd Battery Pack to water spray under pressure.

Battery Installation and Removal

- To install the battery, hold the transceiver with your left hand, so your palm is over the speaker and your thumb is on the top of the Belt Clip. Insert the battery pack into the battery compartment on the back of the radio while tilting the Belt Clip outward, then close the Battery Pack Latch until it locks in place with a “Click.”

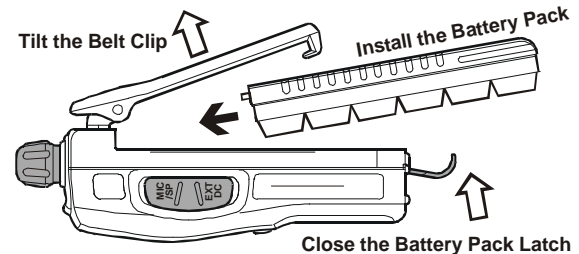

- To remove the battery, turn the radio off and remove any protective cases. Open the Battery Pack Latch on the bottom of the radio, then lift the battery upward and out from the radio while tilting the Belt Clip upward.

 **Do not attempt to open any of the rechargeable Ni-Cd packs, as personal injury or damage to the Ni-Cd pack could occur if a cell or cells become accidentally short-circuited.**

BEFORE YOU BEGIN

Battery Charging

It is necessary to fully charge the Ni-Cd battery before its first use. Follow these procedures:

- Install the supplied **FNB-64** Ni-Cd battery pack onto the transceiver. Ensure that the transceiver is switched off.
- Plug the **NC-77** into the AC line outlet.
- Insert the transceiver and battery pack into the **NC-77**; the antenna jack should be at the left side when viewing the charger from the front.
- If the transceiver and battery pack are inserted correctly, the RED indicator will glow. A fully-discharged pack will be charged completely in 10 hours.

Important Notes:

- ❑ The **NC-77** is not designed to power the transceiver for operation (reception or transmission).
- ❑ Do not leave the charger connected to the transceiver for continuous periods in excess of 24 hours. Long term overcharging can degrade the Ni-Cd battery pack and significantly shorten its useful life.
- ❑ If using a charger other than the **NC-77**, or if using a battery pack other than the **FNB-64**, fol-

low the appropriate instructions provided with the charger/battery. Contact your Dealer if you have any doubts about the appropriateness of the particular charger or battery pack you intend to use.

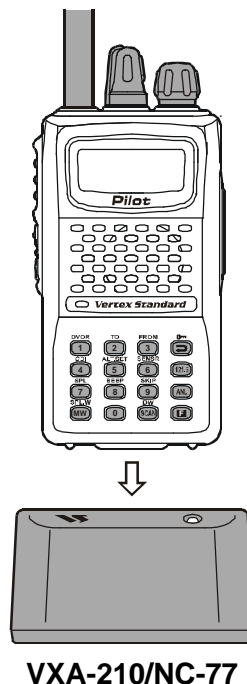

BEFORE YOU BEGIN

Low Battery Indication

- As your battery discharges during use, the voltage will gradually become lower. When the battery voltage reaches 6.0 Volts, the “” icon will blink on the LCD display, indicating that the battery pack must be recharged before further use.
- Avoid recharging Ni-Cd batteries before the “Low Battery” indicator is observed, as this can degrade the charge capacity of your Ni-Cd battery pack. Vertex Standard recommends that you carry an extra, fully-charged pack with you so you will not lose communications capability due to a depleted Ni-Cd battery. This “deep cycling” practice will help to maintain longer overall battery life after many recharging cycles.

Installing the FBA-25 (option) Alkaline Battery Case

The optional **FBA-25** Battery Case allows operation of the **VXA-210** using six “AA” size Alkaline batteries.

When installing batteries, insert the (–) end first, then press in the (+) end so the battery snaps into place. Always replace all six batteries at the same time, paying attention to the polarity indicated inside the case.



The FBA-25 must not be used with rechargeable cells. The FBA-25 does not contain the thermal and over-current protection circuits (provided in the “FNB” series of Ni-Cd Battery Packs) required when utilizing Ni-Cd cells.

OPERATION

Preliminary Steps

- Install a charged battery pack onto the transceiver, as described previously.
- Screw the supplied antenna onto the Antenna jack. Never operate this transceiver without an antenna connected.
- If you have an optional Speaker/Microphone or headset, we recommend that it not be connected until you are familiar with the basic operation of the **VXA-210**.

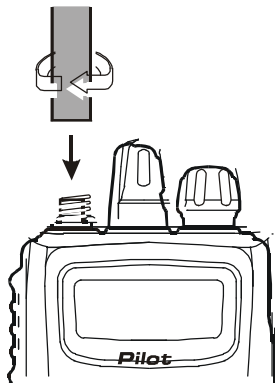

Operation Quick Start

- To turn the radio on, rotate the **VOLUME** knob out of the click-stop.



- After three “initialization” beeps are heard, a channel frequency should appear on the display. If not, press downward (momentarily) on the **DIAL** selector knob (repeatedly, if necessary) so that “- VFO -” appears on the display, followed by a channel frequency.
- Directly entering frequencies from the keypad is the easiest method if you know the frequency on which you wish to operate. Just enter the five digits of the frequency to move to that frequency. *For example*, to set 134.35 MHz, press [1] → [3] → [4] → [3] → [5].

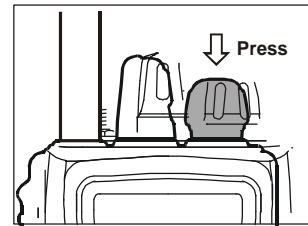

OPERATION

To set 118.275 MHz, you do not need to press the final “5” in the frequency:
[1] → [1] → [8] → [2] → [7].

- ❑ You may also turn the top panel’s **DIAL** selector knob to choose the desired operating frequency. The channel frequency will appear on the LCD.

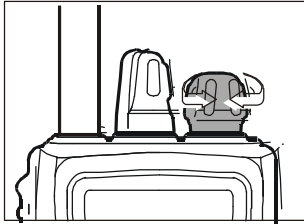

- ❑ To change frequency in 1 MHz steps, press the [F] key momentarily, then rotate the **DIAL** selector knob to select the MHz digit desired. Press [F] once more to resume normal channel selection in 25-kHz steps.

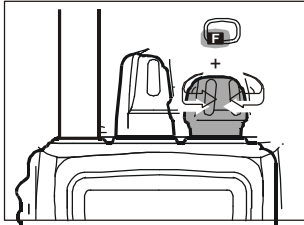

- ❑ Rotate the **VOLUME** knob to set the volume level. If no signal is present, press and hold the **MONITOR** button for 2 seconds; background noise will now be heard, and you may use this noise to set the **VOLUME** knob for the desired audio level. Press the **MONITOR** button momentarily to silence the noise and resume normal (quiet) monitoring.

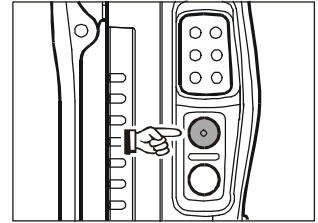
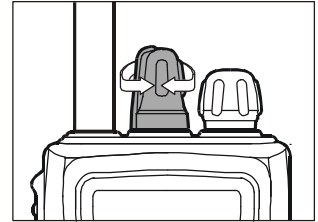

- ❑ Press and hold the **LAMP** button for 2 seconds, to illuminate the display continuously. To disable the illumination, press the **LAMP** button momentarily.

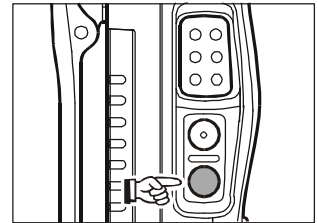

OPERATION

- ❑ To turn the radio off, turn the **VOLUME** knob fully counter-clockwise into the click stop position.

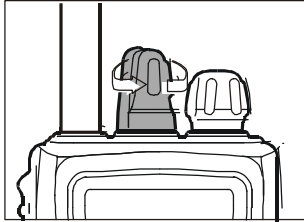

Squelch Adjustment

1. Press the [F] key momentarily, then press downward on the **DIAL** selector knob to activate the Menu (“SET”) mode.
2. Rotate the **DIAL** selector knob to select the Menu Item 01 “SQL.”
3. Press downward on the **DIAL** selector knob, then rotate the **DIAL** selector knob to set the squelch threshold (0 to 8) so that the receiver is just silenced. A higher number indicates that a higher signal level is required in order to open the squelch.
4. Press downward on the **DIAL** selector knob to save your new setting.
5. Press the **PTT** switch to exit the Menu (“SET”) mode.

- Accessing the **121.5 MHz Emergency Frequency**
The **VXA-210** can quickly access the 121.500 MHz Emergency Frequency. This function can be activated even when the keypad lock function is in use.

- ❑ To access the Emergency Frequency, press the [121.5] key momentarily.

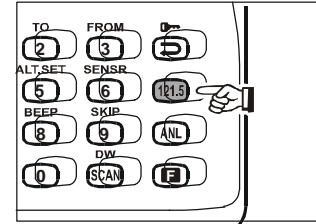

- ❑ To exit the Emergency Frequency, press downward on the **DIAL** selector knob.

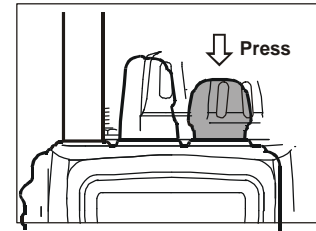

OPERATION

Tuning Methods

Throughout this manual, you will see references to several different frequency setting methods. Each will be particularly useful in a particular operating situation, and they are described below:

○ VFO (Variable Frequency Oscillator)

The VFO is a “tuning dial” system which allows you to tune through the **NAV** or **COM** bands in 25-kHz steps using the **DIAL** selector, the **Key-pad**, or the scanner.



○ MR (Memory Recall)

The MR (Memory Recall) mode of the **VXA-210** provides the user with the ability to store and recall as many as 50 channels in the radio's main memory bank. These memory channels may also be labeled by you with an alpha/numeric name of up to 8 characters in length, to aid in quick identification of the channel. See page 26 for details on creating alpha/numeric labels.

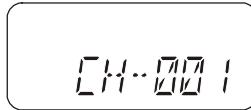

○ BOOK (Pre-Programmed) Memories

The Book memories are pre-programmed, either at the factory or by your Dealer (depending on your country's requirements), typically including the major **COM** and **NAV** band station frequencies used in your area. The Book memories can be changed by the user. See page 39 for details.



○ WX (Weather Channel) Memories

(USA version only)

Ten Weather Channels are pre-programmed at the factory. The **VXA-210** will automatically scan this special bank when it is selected by the user.

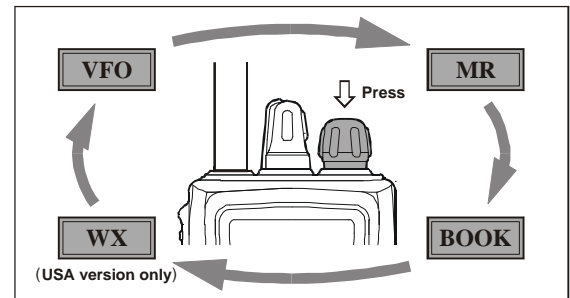
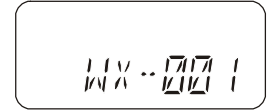

OPERATION

Transmission

To transmit, press and hold the **PTT** switch. Speak into the microphone area of the front panel grille in a normal voice level.

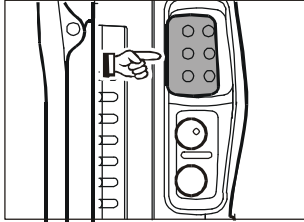

To return to the receive mode, release the **PTT** switch.

Reception of Weather Channel Broadcasts

(USA version only)

The **VXA-210** can receive VHF Weather Channel broadcasts, which may assist your flight planning. The **VXA-210** includes a ten-channel auto-search feature, which simplifies access to Weather Channels when you are in an unfamiliar location.

- To receive Weather Channels, press the **DIAL** selector knob (repeatedly, if necessary) to select the Weather Channel mode. In the Weather Channel mode, “- WX -” will appear on the display.
- The **VXA-210** will now scan quickly through the ten standard Weather Channels, and will stop on the first active station found.

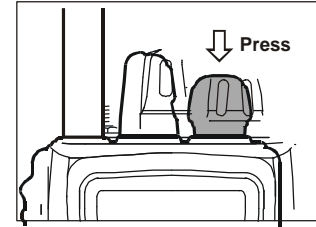

- If there are two or more weather channels audible in your area, you may select the alternate channel(s) by pressing the **PTT** switch.

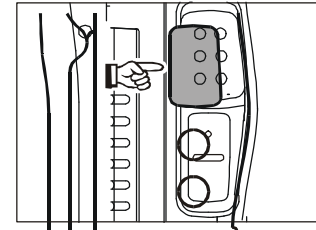

OPERATION

Pressing the **PTT** switch re-initiates the scanning process.

- ❑ If there are no Weather Channels in your area, the scanner will not stop. Press the **MONITOR** button to stop the scanner.
- ❑ You can also select Weather Channels manually by rotating the **DIAL** selector knob.

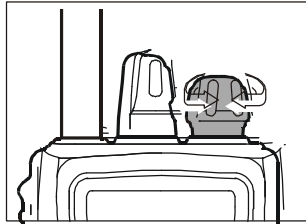
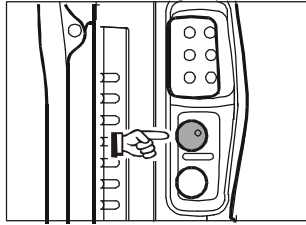

- ❑ To confirm the current Weather Channel frequency, press the [↔ (🔑)] key momentarily. The display changes to *frequency indication*. Press the [↔ (🔑)] key again to return to normal display.

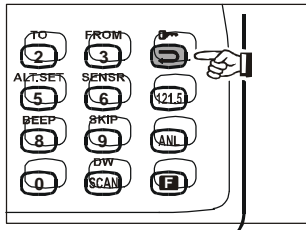

- ❑ To exit the Weather Channel mode, press the **DIAL** selector knob momentarily to return to the VFO mode.

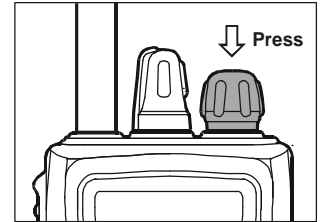

Note: The Weather Channel mode memorizes the last Weather Channel you have used, and will retain this information until the radio is turned off.

OPERATION

Monitor Key

When listening to a very weak signal from an aircraft or ground station, you may observe the signal disappearing periodically as the incoming signal strength becomes too weak to override the squelch threshold setting.

To disable the squelch temporarily, press and hold the **MONITOR** key for 2 seconds on the left side of the radio, just below the **PTT** button. The squelch will remain open and you should have a better chance of hearing weak signals.

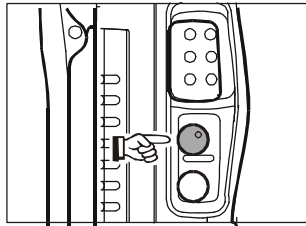

To return to normal operation, press the **MONITOR** key momentarily.

ANL (Automatic Noise Limiter) Feature

For reduction of impulse noise, such as that produced by an engine's ignition system, the ANL feature may prove helpful.

- ❑ To activate the ANL feature, press the **[ANL]** key momentarily. The “**ANL**” icon will appear on the display, and you should observe a reduction in the ignition noise.

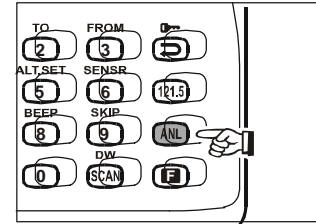

- ❑ To turn the ANL feature off, repeat the above step; the “**ANL**” icon will disappear from the display.

OPERATION

Temperature Display

The **VXA-210** can measure the current temperature.

- ❑ To display the current temperature, press **[F]** → **[6 (SENSR)]**. The display will now indicate the current temperature.

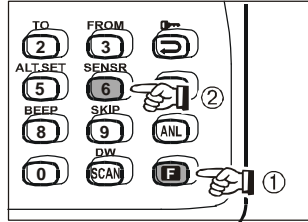

- ❑ Pressing the **[↔ (key)]** key to switch the temperature unit between “Celsius: °C” and “Fahrenheit: °F.”

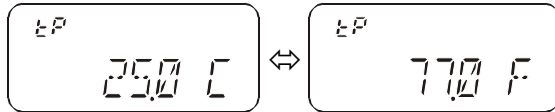

- ❑ Press the **PTT** switch to return to the normal operation.

If the temperature display is incorrectly, it can be recalibrated. See page 22 for details.

LOCK Function

The lock function prevents accidental changes to the frequency setting and the keypad controls.

- ❑ To activate the lock feature, press **[F]** → **[↔ (key)]**.
- ❑ In the LOCK mode, the display will show “- LOCK -” when you rotate the **DIAL** selector knob, press the **DIAL** selector knob, or touch a key on the keypad.
- ❑ To turn the lock feature off, press **[F]** → **[↔ (key)]** again.
- ❑ You can still access the 121.500 MHz Emergency Frequency when the LOCK function is on. Simply press the **[121.5]** key momentarily (this key *never* locks). Pressing this key also unlocks the radio.

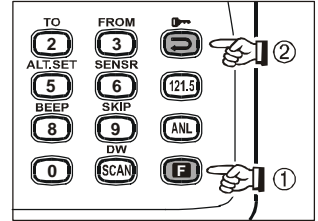

OPERATION

Receive Battery Saver Setup

An important feature of the **VXA-210** is its Receive Battery Saver, which “puts the radio to sleep” for a time interval, periodically “waking it up” to check for activity. If somebody is talking on the channel, the **VXA-210** will remain in the “active” mode, then resume its “sleep” cycles. This feature significantly reduces quiescent battery drain, and you may change the amount of “sleep” time between activity checks using the Menu System:

- Press the [**F**] key, then press the **DIAL** selector knob to activate the Menu (“SET”) mode.
- Rotate the **DIAL** selector knob to select Menu Item 06 “**RS**AV.”
- Press the **DIAL** selector knob to enable adjustment of this Menu item.
- Rotate the **DIAL** selector knob to select the desired “duty cycle” (receive:sleep). The selections available are 1:1, 1:2, 1:3, 1:4, 1:5, and ABS* or OFF. The default value is 1:1.
- When you have made your selection, press the **DIAL** selector knob to save the new setting, and then press the **PTT** key exit to normal operation.

※ABS: Automatic Battery Saver, based on activity on the receiver.

The setting of 1:5 will promote the greatest conservation of battery capacity, but the receiver’s response time to incoming calls will be slowed somewhat.

Note: This feature does not operate during Scan or Dual Watch.

Beep On/Off

The **VXA-210**'s key/button beeper provides convenient audible feedback whenever a button is pressed. Each key and button has a different beep pitch, and each function has a unique beep combination.

When you are scanning, the beeper will be heard each time the scanner halts on a busy channel. This may be distracting in some environments; if you want to turn the beeper *off* (or back on again):

- Press [**F**] → [**8 (BEEP)**]; “05 BEEP” will appear on the LCD.
- Press downward on the **DIAL** selector knob to enable On/Off selection for the beeper.
- Rotate the **DIAL** selector knob one click to change the display to “**BEEP OFF.**”
- Press downward on the **DIAL** selector knob to save the new setting.
- Press the **PTT** switch momentarily to exit to normal operation.

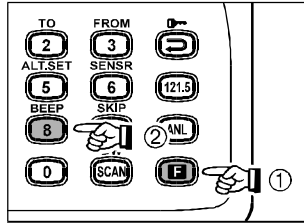

BAROMETRIC PRESSURE/ALTITUDE METERING

Thermometer Calibration

- ❑ Press the [F] key, then press the **DIAL** selector knob to activate the Menu (“SET”) mode.
- ❑ Rotate the **DIAL** selector knob to select Menu Item 14 “TEMP.”
- ❑ Press the **DIAL** selector knob to enable adjustment of this Menu item.
- ❑ Rotate the **DIAL** selector knob to set the difference (value: in °C) between the **VXA-210** display and the calibrated thermometer. *For example*, if the **VXA-210** display shows “24.5 C” and the thermometer (wrongly) indicates “24.0 °C,” set the **TEMP** offset to “-005”.
- ❑ Press the **DIAL** selector knob to save the new setting, and then press the **PTT** key exit to normal operation.

The optional Barometric Pressure Unit (**SU-1**) brings to the **VXA-210** the unique capability of providing readout of the current barometric pressure. This information is used for calculation of your current altitude, and also used for calculation of your current density Altitude using with the temperature sensor.

The Barometric Pressure unit and temperature sensor requires calibration of the “offset” parameters, so that differences in pressure can be used to calculate altitude. This procedure requires that you have a calibrated barometer, calibrated thermometer, and that you know your current altitude. If you are at sea level, of course, the latter parameter requires no research.

Notice

The optional **SU-1** Barometric Pressure Unit for the **VXA-210** measures pressure in the immediate vicinity of the transceiver. When using the **VXA-210** equipped with the **SU-1** in a pressurized cabin of an aircraft, of course, the **VXA-210** will not be able to measure outside temperature and pressure, nor display altitude accurately.

Please rely on your aircraft’s altimeter for such data.

BAROMETRIC PRESSURE/ALTITUDE METERING

Correcting the Atmospheric Pressure Meter (Barometer Offset)

- ❑ Press the **[F]** key, then press the **DIAL** selector knob to activate the Menu (“SET”) mode.
- ❑ Rotate the **DIAL** selector knob to select Menu Item 15 “BARO.”
- ❑ Press the **DIAL** selector knob to enable adjustment of this Menu item.
- ❑ Rotate the **DIAL** selector knob to set the difference (value: in hpa) between the **VXA-210** display and the calibrated barometer display. *For example*, if the **VXA-210** display shows “1024 hPA” and calibrated barometer indicates “1029 hpa,” set the Barometer offset to “+005”.
- ❑ Press the **DIAL** selector knob to save the new setting, and then press the **PTT** key exit to normal operation.

Correcting the Altimeter Setting (Altimeter Offset)

- ❑ Press **[F]** → **[5 (ALT.SET)]** to enable the Altimeter Set function.
- ❑ Enter the proper local barometric pressure value (in “HG”) of the airport directly from the keypad. *For example*, if the current Barometric Pressure at the airport is “30.05 HG,” press **[3]** → **[0]** → **[0]** → **[5]** on the keypad.
- ❑ Press the **PTT** key to save the new setting and exit to normal operation.

When the Altimeter function is brought up (by pressing **[F]** → **[6 (SENSR)]**), the **VXA-210** will now display your correct altitude (+/- tolerance of the **SU-1**). Please remember that the Altitude function of the **VXA-210** is not intended to serve as your primary altimeter instrument.

Once you have completed the above calibrations, you can confirm the current Temperature, Barometric Pressure, Altitude, or Density Altitude.

BAROMETRIC PRESSURE/ALTITUDE METERING

How to Measure the Barometric Pressure or Altitude

- ❑ Press [F] → [6 (SENSR)]; the display will show current temperature.
- ❑ Rotate the **DIAL** knob to select the desired sensor (see next page).
- ❑ Press the [↶ (KEY)] key to change the measurement units of the current sensor (or On/Off the Pressure Graph).
- ❑ Press the **PTT** key exit to normal operation.

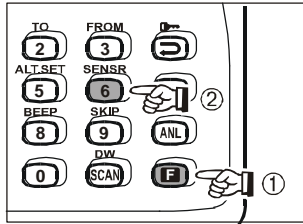

Weather Sensor Mode

The Weather Sensor Mode allows the user to activate only the sensor and display circuits of the **VXA-210**, for use of the radio solely as a weather monitor. With the “radio” circuits not being activated, battery consumption is reduced significantly.

1. Press and hold in the **MONITOR** and **LAMP** keys while turning the radio on, activate the Weather Sensor Mode.
2. Turn the **DIAL** knob to select the desired sensor among from the “TEMP,” “BARO,” “ALTI,” “GRPH,” and “D.ALT” selection.
3. Press the [↶ (KEY)] key to change the measurement units of the current sensor, if desired.
4. Turning the radio off, then on again, will return the **VXA-210** to normal operation.

BAROMETRIC PRESSURE/ALTITUDE METERING

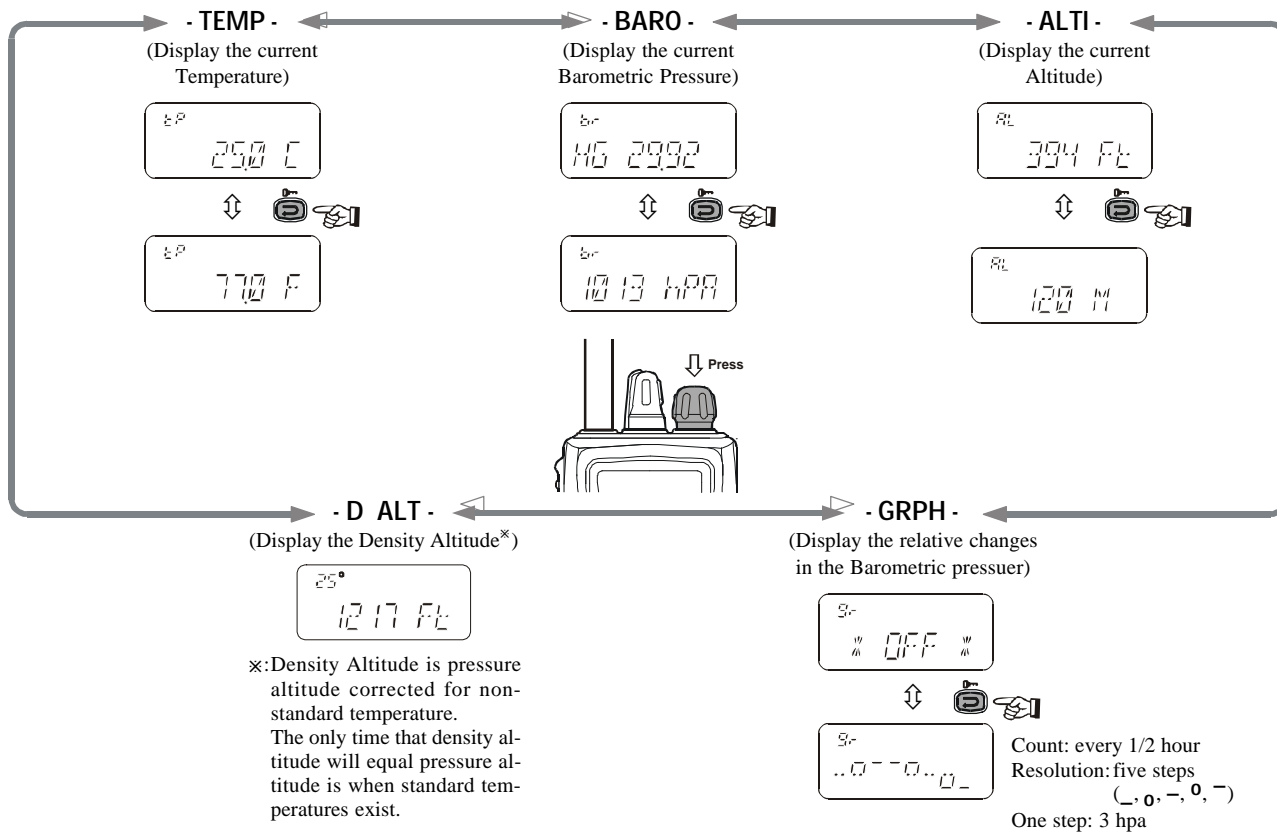

※: Density Altitude is pressure altitude corrected for non-standard temperature. The only time that density altitude will equal pressure altitude is when standard temperatures exist.

MEMORY OPERATION

The **VXA-210** provides 50 user-programmable “Main” memories, labeled “CH-001” through “CH-050,” and up to 100 pre-programmed memories, designated “Book” Memories. The “” icon appears when “Book” Memory Mode is activated.

The Main memories and “Book” Memories can be assigned alpha-numeric names of up to eight characters.

Memory System Operation

The **VXA-210**’s Main Memory system allows the user to store, label, and recall channel frequencies which you may want to use frequently. You may store VFO frequencies, Book Memory frequencies, and/or Weather Channel frequencies (USA version only) into the Main Memory system.

Memory Storage

- Select the desired frequency in the VFO mode, or recall the Book Memory channel or Weather channel to be stored in the Main Memory.
- Press and hold the [**MW (SPL.W)**] key for 2 seconds. The display will indicate “CH-” and a channel number will blink on the LCD.
- Within five seconds of pressing the [**MW (SPL.W)**] key, rotate the **DIAL** selector knob to select the desired memory channel number for storage.

In order to prevent writing over memory channels, a bar will appear under the hyphen (located between “CH” and the channel number) to indicate a vacant memory channel.

- Now press and hold in the [**MW (SPL.W)**] key for 2 seconds; you will now see “-.....” on the LCD. To attach an alpha/numeric name (label) to the memory, proceed to the next step; otherwise press and hold [**MW (SPL.W)**] for 2 seconds to save the entry and exit.
- To label a memory with an alpha/numeric name, the next step is to use the **DIAL** selector knob to select any of the 48 available characters (including letters, numbers, and special symbols). When

MEMORY OPERATION

the desired first character appears, press the **DIAL** selector knob momentarily to move on to the next character.

- ❑ Select succeeding characters in the same manner, pressing the **DIAL** selector knob momentarily after each selection.
- ❑ After entering the entire name (eight characters maximum), press the **[MW (SPL.W)]** key for 2 seconds to save all data for the channel and exit.

Note: If you have stored a Weather Channel, the “WX-001 ~ WX-010” labels utilize the alphanumeric memory, and other labels may not be stored.

Alpha-tag Characters											
0	1	2	3	4	5	6	7	8	9	A	B
C	D	E	F	G	H	I	J	K	L	M	N
O	P	Q	R	S	T	U	V	W	X	Y	Z
	<	>	+	÷	*	/	Δ	μ	Σ		.

Recalling the Memories

- ❑ Press the **DIAL** selector knob, repeatedly if necessary, until “MR” (**M**emory **R**ecall) appears on the display. In the MR mode, you will see “CH-” and the previously selected channel number appearing on the LCD.
- ❑ Rotate the **DIAL** selector knob to select the desired memory channel.
- ❑ You may change the title structure of the Memory display type among:
 1. Channel Indication (sequential Channel Number, e.g. CH-001, CH-002, etc.);
 2. Frequency Indication (e.g. 122.500); or
 3. Alphanumeric Label (e.g. LAX FSS).
- ❑ To change the Memory display title, press the **[↔ (0↔)]** key repeatedly, if necessary, until you get the desired display title structure.
- ❑ To exit the Memory mode, press the **DIAL** selector knob momentarily to return to the VFO mode.

Note: In either the “MR” or the “Book” Memory mode, you can change memory channels in 10 channel steps: press the **[F]** key momentarily, then rotate the **DIAL** selector knob. The “**F**” icon will show at the right edge of the display when the 10 channel step tuning mode is active. Press the **[F]** key once more to resume normal channel selection in 1 channel steps.

SCANNING OPERATION

The **VXA-210** allows you to scan automatically in the VFO*¹, Main Memory, “Book” Memory, or Weather Channel*² modes. It pauses on signals encountered, so you can talk to the station(s) on that frequency, if you like.

※1: In the VFO mode, the *automatic* scanner is only available in the **COM** band (118.000 - 136.975 MHz); when the scanner reaches the uppermost frequency in the **COM** band, it will revert to the bottom end of the **COM** band and repeat the scanning process until you cancel the scanning process.

※2: USA version only.

If you wish to scan in the **NAV** band (108.000 - 117.975 MHz), you can do so manually, as described at the right.

Scanning operation is basically the same in each of the above modes.

- ❑ Press the [**SCAN (DW)**] key momentarily to start the automatic scanner *upward* (toward a higher frequency or a higher channel number).
- ❑ When the scanner encounters a signal, scanning pauses and the radio remains on that channel until one second after the signal disappears, after which scanning will resume.

- ❑ While the scanner remains paused on a frequency, the decimal point of the frequency display blinks. The display will be illuminated unless the Scan Lamp Feature is turned off.
- ❑ To change the scan direction, turn the **DIAL** selector knob *one click* in the opposite direction.
- ❑ To stop the automatic scanner, press the **PTT** switch or the **DIAL** selector knob momentarily. You may also press [**SCAN (DW)**] key again.

The **VXA-210**'s automatic scanner is not operational in the **NAV** band (108.000 - 117.975 MHz), because the **NAV** stations (ILS, etc.) transmit constantly (thereby causing the scanner to stop repeatedly). However, you *can* scan manually in the **NAV** band, per the following procedure:

- ❑ Press and hold the [**SCAN (DW)**] key to start the manual scanner. Scanning will continue as long as the key is depressed.
- ❑ Release the [**SCAN (DW)**] key to stop the manual scanner immediately.

Note: When scanning upward in frequency, when the frequency reaches the **COM** Band (118.000 - 136.975 MHz) via manual scanning, The **VXA-210** will switch to the *automatic* scanner mode.

SCANNING OPERATION

Channel-Skip Scanning

Continuous-carrier stations like ATIS (Automatic Terminal Information Service) or Weather Broadcast stations inhibit scanner operation. Since these stations are always active, the scanner will be halted repeatedly on their channels. Such channels can be set to be “skipped” during Memory scanning (MR, Book or WX modes), if you like, so as not to interfere with automatic channel scanning:

- ❑ Recall the Memory Channel to be skipped during scanning.
- ❑ Press [F] → [9 (SKIP)]. The “◀” icon will appear in the lower right corner, indicating that the channel is to be ignored during scanning.
- ❑ You can also designate a channel to be skipped while scanning. When the receiver is halted on a channel that you wish to skip, press and hold the [SCAN (DW)] key for 2 seconds (the “◀” icon will appear next to the channel to be skipped).
- ❑ Later, to re-enable the memory channel for scanning, repeat the first two steps. The “◀” icon will disappear by the channel you have just re-enabled.

Note: A memory set to be “skipped” is still accessible for *manual* memory selection using the **DIAL** selector knob.

DUAL WATCH OPERATION

The Dual Watch feature automatically checks for activity on a “priority” channel* while you are operating on another channel. During Dual Watch operation, the current channel and the Priority channel will each be polled for a 500 ms interval, as the **VXA-210** looks for activity on each channel.

- To start Dual Watch, press [F] → [SCAN (DW)]. The “DW” icon will appear on the display.
- While receiving on the “current” channel (not the Priority channel), you may push the **PTT** switch at any time to transmit on that channel.
- When a signal is received on the Priority channel, operation immediately shifts to the Priority channel, the “DW” icon will blink, and the display will become illuminated.

While receiving on the priority channel, if you momentarily press the **PTT** switch, Dual Watch will be disabled. You may then transmit on the Priority Channel.

- To stop Dual Watch, press [F] → [SCAN (DW)].
- If you wish, you may use both the Dual Watch and Scan features simultaneously. To do this, start the Dual Watch first, then start the Scanner.

※ The “Priority” Channel is defined as the *last-used Memory Channel* (when using the VFO mode) or *Memory Channel 1* (when using the Main Memory or Book Memory modes).

PRIORITY DUAL WATCH OPERATION

Similar to Dual Watch operation (described on previous page), Priority Dual Watch is an enhanced version which includes the following additional features:

- The receiving time interval (ratio) between the current channel and the Priority channel may be customized via the Menu Item “**PRTM.**” See page 43 for details.
- Irrespective of which channel is currently being received, when the **PTT** button is pushed transmission will *always* occur on the Priority channel.

Before initiating Priority Dual Watch, Menu Item 10 “**DWMD**” must be set to the “Priority” mode (instead of “Dual Watch”). See page 43 for details.

- To start Priority Dual Watch, press [**F**] → [**SCAN (DW)**]. The “**DW**” icon will appear on the display.
- While receiving on the “current” (non-Priority) channel, pressing the **PTT** button once causes the radio to switch to the Priority channel and cancels Dual Watch. Press the **PTT** button again to transmit on the Priority channel.
- When a signal is received on the Priority channel, reception immediately shifts to the Priority channel, the “**DW**” icon will blink, and the display will become illuminated unless the Scan Lamp Feature is turned off.
While receiving on the priority channel, if you momentarily press the **PTT** switch, Priority Dual Watch will be disabled. You may then transmit on the Priority Channel.
- To stop Priority Dual Watch, press [**F**] → [**SCAN (DW)**].

VOR NAVIGATION

General VOR Equipment

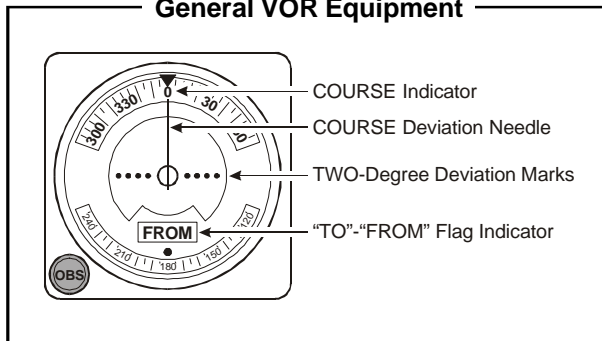

COM BAND (118.000 - 136.975 MHz)

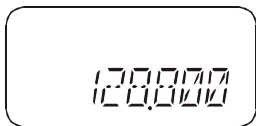

NAV BAND (108.000 - 117.975 MHz)

DVOR MODE

COURSE Indicator "TO"-"FROM" Flag Indicator

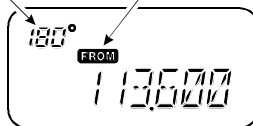

CDI MODE

COURSE Indicator COURSE Deviation Needle

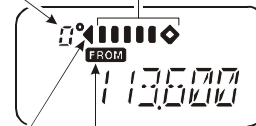

"TO"-"FROM" Flag Indicator
OVERFLOW Indicator

VOR NAVIGATION

To Select the DVOR Mode

- ❑ When entering the NAV band (108.000 - 117.975 MHz), the **VXA-210** selects the DVOR mode automatically. The “**COURSE INDICATOR**” field will appear at the upper left corner on the display, and the “**TO**” or “**FROM**” indicator will appear above the frequency display on the display.

Note: The “**COURSE INDICATOR**” indicates “- - -” when either your aircraft is too far away from the VOR station or the frequency is not correctly set to that of the VOR station. Conversely, the “**COURSE INDICATOR**” will indicate “**loc**” when a localizer signal is being received.

- ❑ The “**TO**” or “**FROM**” flag indicators indicate whether the VOR navigation information is based on a course leading to the VOR station or leading away from the VOR station.
- ❑ To change the flag from “**TO**” to “**FROM**” or vice versa, press the [F] → [3 (FROM)] or [2 (TO)] key, respectively.
- ❑ The small “**COURSE INDICATOR**” and “**TO/ FROM**” flag indicators may be toggled to the larger “frequency” portion of the display. To do this, press and hold in the [↩ (0)] key for 2 seconds to toggle to the larger display area. Press

the [↩ (0)] key momentarily again to return to the smaller displays.

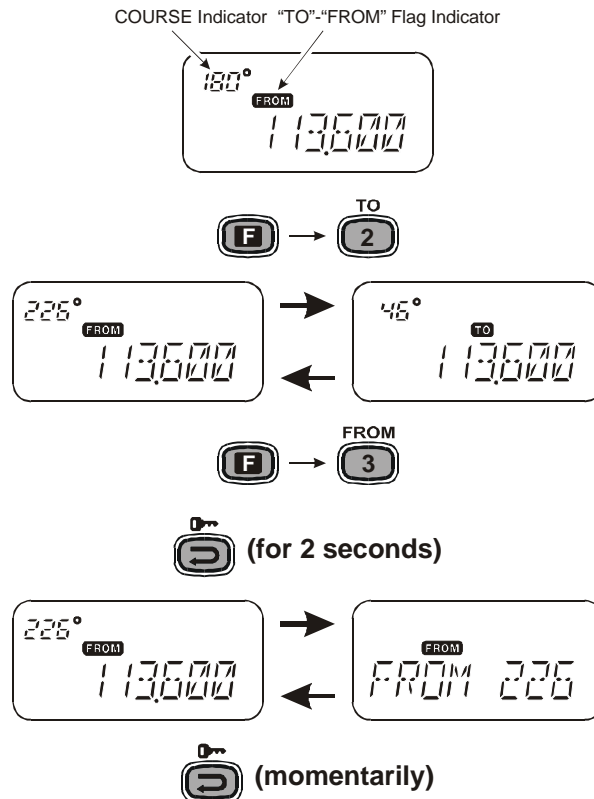

VOR NAVIGATION

Flying to a VOR Station

The **VXA-210** can indicate the deviation from the direct course to a VOR station.

- ❑ Select a VOR station on your aeronautical chart and turn the **DIAL** selector knob (or enter the frequency directly with the keypad) to the frequency of the VOR station.
- ❑ To indicate the deviation between your current flight path and the desired course, press **[F] → [4 (CDI)]** to change to the CDI (Course Deviation Indicator) mode. The “**COURSE DEVIATION ARROW**” will appear above the frequency field on the display when your aircraft is off the direct course to the VOR station.
- ❑ When your aircraft is off course to the *right*, the Course Deviation Arrow display will show bars to the left side of the diamond (“**||◇**”). When your aircraft is off course to the *left*, the Course Deviation Arrow display will show bars to the right side of the diamond (“**◇||**”). Correct your course until no bars appear on either side of the CDI “diamond” (only “**◇**” will be visible when the heading is correct).
- ❑ To return to the DVOR mode, press **[F] → [1 (DVOR)]**.

The Aircraft is “ON COURSE”

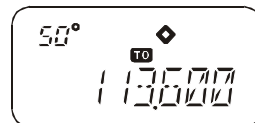

OFF COURSE to the “right” 6 degrees

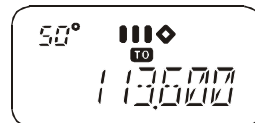

OFF COURSE to the “left” 6 degrees

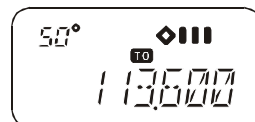

VOR NAVIGATION

The Aircraft is "ON COURSE"

VOR (TAC)
Los Angeles
LAX - 113.600MHz

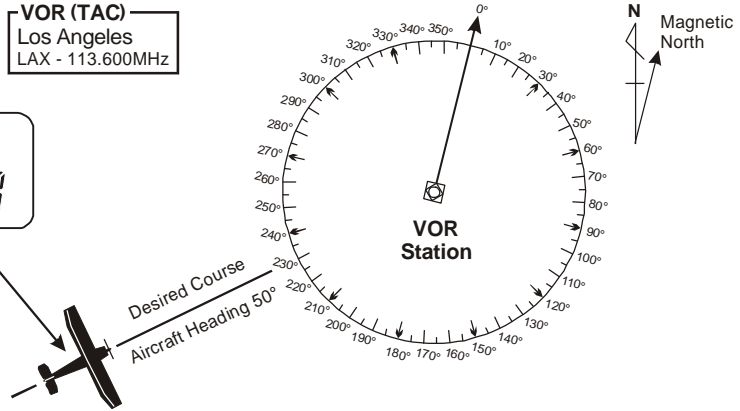
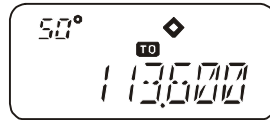

The Aircraft is "OFF COURSE"

VOR (TAC)
Los Angeles
LAX - 113.600MHz

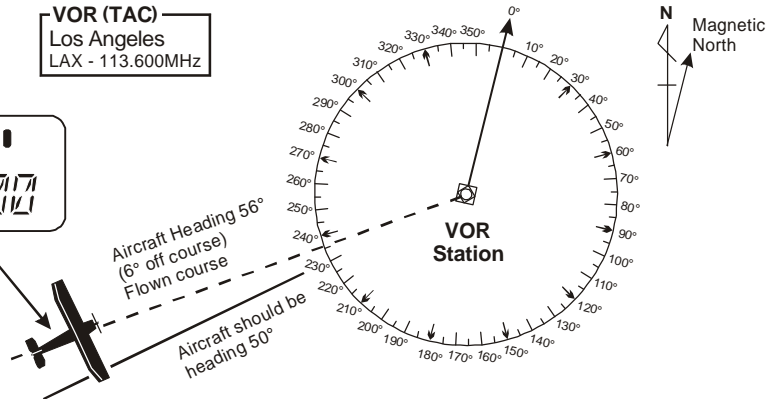
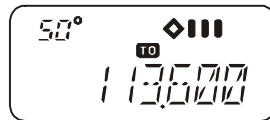

VOR NAVIGATION

Entering a Desired Course

The **VXA-210** can also be configured to indicate the deviation from the desired course, not only the deviation from the path to the VOR station.

- Set the frequency to the desired VOR station.
- To change the “**TO**” or “**FROM**” flag to “**TO**”, if it is not in that mode already.
- Press [**F**] → [**4 (CDI)**] key to change to the CDI mode.
- Set the desired course to the VOR station using the **DIAL** selector knob or keypad (three digits input; e.g. 47°, press [**0**] → [**4**] → [**7**]).

Note 1: The (“||◇”) or (“◇||”) indication will appear on the display when your aircraft is off the desired course.

Note 2: When your heading is correct, the **ABCS** function may be more useful than the course input option.

- The **COURSE DEVIATION ARROW** points to the *right* when your aircraft is off course to the *left*, and it points to the *left* when your aircraft is off course to the *right*.

Note 1: To get back on course, fly right more than the number of degrees indicated by the **COURSE DEVIATION ARROW**.

Note 2: If the overflow indicator “▶” appears on the right side, select a heading plus 10 degrees to the desired course; if the overflow indicator “◀” appears on the left side, select a heading minus 10 degrees.

ABCS Mode

In the CDI mode, the Auto Bearing Center System (**ABCS**) adds or subtracts the number of degrees indicated by the CDI from the Omni Bearing Selector (**OBS**).

VOR NAVIGATION

Position Cross-checking

- Select two VOR stations on your aeronautical chart.
- Set the frequency of one of the VOR stations in the DVOR mode. The course indicator will show the course deviation from the VOR radial. Note the radial you currently are on.
- Now set the frequency of the other VOR station in the DVOR mode. Note the radial from the station you are on.
- Extend the radials from each VOR station on the chart. Your aircraft is located at the point where the lines intersect.

Cross-checking Position

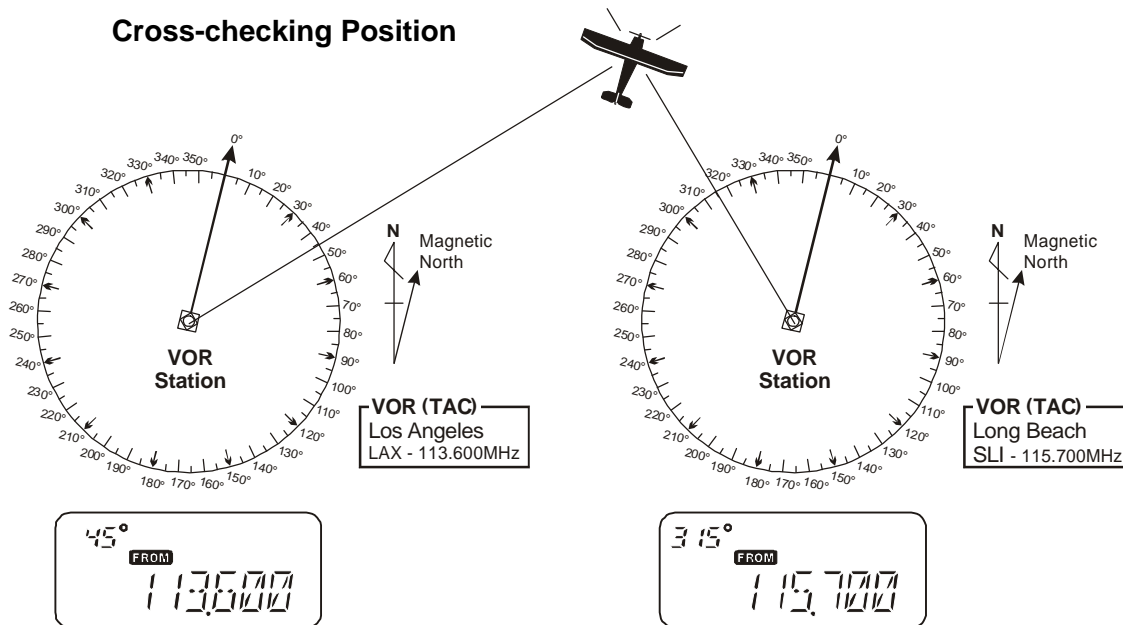

VOR NAVIGATION

Split Operation

The split operation feature allows you to transmit a call to a Flight Service Station using the **COM** band frequencies, while receiving a VOR station (in the **NAV** band). VOR stations equipped with this capability typically are shown, on navigation charts, with the voice calling frequency in parenthesis above the navigation frequency.

Programming a Transmit Frequency

- Press the **DIAL** selector knob, repeatedly if necessary, to select the VFO mode.
- Set a **NAV** band (108.000 - 117.975 MHz) frequency using the **DIAL** selector knob or keypad.
- Press [**F**] → [**MW (SPL.W)**]. The “**SPL**” icon will blink, and the transmit frequency will appear on the display.
- Now set your radio’s transmit frequency, where the Flight Service Station will be listening for calls, using the **DIAL** selector knob or keypad.
- Press and hold in the [**MW (SPL.W)**] key for 2 seconds to save the transmit frequency and return to the **NAV** band frequency.

Note: You have now **stored** the separate transmit frequency, but you have not yet **activated** the *split-frequency function*; go on to the next section.

Operating in the Split Mode

- It is assumed that you have already set the desired VOR station’s frequencies (in the **NAV** band) per the above instructions.
- Press [**F**] → [**7 (SPL)**] to turn on the “Split” function. The “**SPL**” icon will appear on the display.
- Press and hold in the **PTT** switch to transmit on the split transmit frequency.
- Release the **PTT** switch to return to the receive mode.
- To disable the “Split” function, press [**F**] → [**7 (SPL)**] again.

Note: A split frequency can be programmed into each memory channel independently. Set a transmit frequency before programming the memory channel, if desired. The split function on/off setting can also be programmed into a memory channel.

FIELD PROGRAMMING MODE

The **VXA-210**'s Book Memories also allow the user to store, label, and recall channel frequencies which you may want to use frequently while the **VXA-210** is in the Field Programming mode.

Memory Storage into the Book Memory

- Press and hold the **PTT** and **LAMP** switches while turning the radio on, to activate the Field Programming Mode.
 - Select the desired frequency to be stored in the Book Memory.
 - Press and hold the **[MW(SPL.W)]** key for 2 seconds. The display will indicate “**BOOK -**” and a channel number will blink on the LCD.
 - Within five seconds of pressing the **[MW(SPL.W)]** key, rotate the **DIAL** selector knob to select the desired memory channel number for storage.
 - Now press and hold in the **[MW(SPL.W)]** key for 2 seconds; you will now see “**-.....**” on the LCD. To attach an alpha/numeric name (label) to the memory, proceed to the next step; otherwise press and hold the **[MW(SPL.W)]** key for 2 seconds to save the entry and exit.
- To label a memory with an alpha/numeric name, the next step is to use the **DIAL** selector knob to select any of the 48 available characters (including letters, numbers, and special symbols). When the desired first character appears, press down on the **DIAL** selector knob momentarily to move on to the next character.
 - Select succeeding characters in the same manner, pressing down on the **DIAL** selector knob momentarily after each selection.
 - After entering the entire name (eight characters maximum), press the **[MW(SPL.W)]** key for 2 seconds to save all data for the channel.
 - Repeat this procedure to store additional frequencies into the Book Memory section, as desired.
 - Turn the radio off, then turn the radio back on again to begin normal operation.

MENU (“SET”) MODE

The Menu system allows certain aspects of your radio’s configuration to be customized for your personal operating convenience. We do not recommend that any of the default settings be changed, however, until you are thoroughly familiar with the operation of the **VXA-210**.

1. Press the [**F**] key, then press the **DIAL** selector knob to activate the Menu (“SET”) mode.

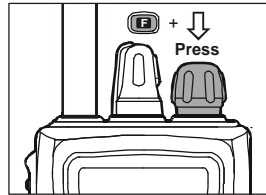

2. Rotate the **DIAL** selector knob to select the Menu item (feature) you wish to view and/or modify.

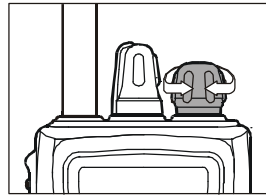

3. Once you have selected the desired Menu Item, press the **DIAL** selector knob once to view the current setting for the item.

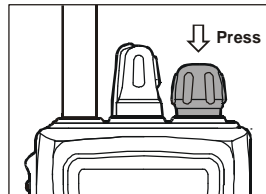

4. Rotate the **DIAL** selector knob to change the setting of the item (ON to OFF, etc.).

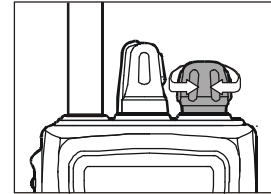

5. Press the **DIAL** selector knob to save your new setting.

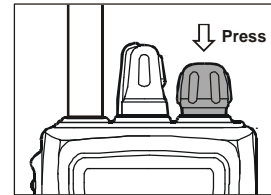

6. If you need to change more than one Menu item, repeat steps 2 - 5.

7. Press the **PTT** switch to exit the Menu (“SET”) mode.

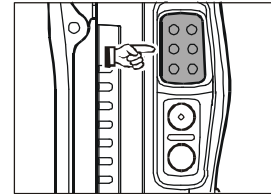

MENU (“SET”) MODE

MENU Listing

A listing of the Menu items available via the SET mode may be found below.

Menu No.	Menu Item	Function	Available Values	Default
01	SQL	SQL Squelch Level Setting	0 ~ 8	2
02	MCLR	Memory Channel Clear	—	—
03	RESM	Scan-Resume Mode Setting	CAR/5	CAR
04	SCNL	Scan Lamp On/Off	on/oFF	on
05	BEEP	Keypad Beeper On/Off	on/oFF	on
06	RSBV	Receiver Battery Saver	oFF/ABS/ 1:1 ~ 1:5	1:1
07	LAMP	LCD Illumination Mode	KEY/TGL/5	KEY
08	SFT	CPU Clock Shift	on/oFF	oFF
09	PRTM	Priority Checking Time	05/10/15/ 20/25/30	15 (1.5 sec)
10	DWMD	Select the Dual Watch/Priority Function	DW/PRI	DW
11	POBP	Select the Power on Beep	0/1/2/3	1
12	IMIC	Internal Microphone On/Off	on/oFF	oFF
13	EMRG	Emergency Channel On/Off	on/oFF	on
14	TEMP	Correcting the Temperature setting	-12.7 ~ +12.7 °C	0 °C
15	BARO	Correcting the Atmospheric pressure	-127 ~ +127 hpa	0 hpa

01 [SQL]

Function: Squelch Level Setting

Available Values: 0 ~ 8

Default Setting: 2

Select a setting for this Menu item which just silences the receiver when no signal is present. Use the lowest setting which will keep the receiver quiet between incoming transmissions.

02 [MCLR]

Function: Memory Channel Clear (“MR” memory only)

To Clear a Memory channel:

1. Select the Menu Item **MCLR**.
2. Press the **DIAL** selector knob, then rotate the **DIAL** selector knob to recall the memory channel to be erased (“**MCLR xx**” will appear on the display).
3. Press the **DIAL** selector knob to clear the Memory channel (Memory channel number will disappear).

Important Notice: An “erased” channel cannot be restored, and “**CH-001**” cannot be erased, as it is used for “Priority Channel” operation.

MENU (“SET”) MODE

03 [RESM]

Function: Scan-Resume Mode Setting

Available Values: CAR/5

Default Setting: CAR

In the “CAR” (Carrier Drop) mode, the scanner will remain halted for as long as there is a carrier present on the channel; after the carrier drops at the end of the other station’s transmission, the scanning will resume.

In the “5” (5-Second Pause) mode, the scanner will halt for five seconds only, after which scanning will resume (whether or not the other station is still transmitting).

04 [SCNL]

Function: Scan Lamp On/Off (while paused)

Available Values: on/oFF

Default Setting: on

If you set this function to “on,” the lamp will be illuminated whenever the scanner pauses. The lamp will go off automatically when scanning resumes.

05 [BEEP]

Function: Keypad Beeper On/Off

Available Values: on/oFF

Default Setting: on

If you do a lot of scanning, you may wish to set this Menu item to “oFF,” as the Beeper will be heard each time the scanner pauses.

06 [RSAV]

Function: Receive Battery Saver

Available Values: 1:1 ~ 1:5/oFF/ABS*

Default Setting: 1:1

The setting of 1:5 will promote the greatest conservation of battery capacity, but the receiver’s response time to incoming calls will be slowed somewhat.

※ABS: Automatic Battery Saver, based on activity on the receiver.

Note: This feature does not operate during Scan or Dual Watch.

MENU (“SET”) MODE

07 [LAMP]

Function: Display and Keypad Illumination Mode

Available Values: KEY/TGL/5

Default Setting: KEY

In the “KEY” mode, the lamp will be activated for 5 seconds when any front panel key is pressed.

In the “TGL” mode, the **LAMP** switch toggles the lamp on and off.

In the “5” mode, the **LAMP** switch activates the lamp for 5 seconds.

08 [SFT]

Function: CPU Clock Shift

Available Values: on/off

Default Setting: off

This function is only used to move a spurious response “birdie” should it fall on a desired frequency. Consult your Yaesu dealer for details regarding this function.

09 [PRTM]

Function: Priority Checking Time

Available Values: 05/10/15/20/25/30 (x0.1 sec)

Default Setting: 15 (1.5 seconds)

This Menu item allows you to define how often the Priority Channel will be checked for activity.

Note: The Dual Watch Polling time is 500 mS (fixed).

10 [DWMD]

Function: Select the Dual Watch/Priority Function

Available Values: DW/PRI

Default Setting: DW

In the DW mode, the **VXA-210** will activate the Dual Watch feature when you press [F] → [SCAN (DW)].

In the PRI mode, the **VXA-210** will activate the Priority feature when you press [F] → [SCAN (DW)].

11 [POBP]

Function: Select the Power on Beep

Available Values: 0/1/2/3

Default Setting: 1

12 [IMIC]

Function: Internal Microphone On/Off

Available Values: on/off

Default Setting: off

This controls the status of the radio’s internal microphone when an external microphone (such as the **MH-44A4B** Speaker Microphone or an aviation headset connected via the **CT-60** Headset Cable) is in use. In most applications, set 12 [IMIC] to “off” for proper operation (this disables the internal microphone). The internal microphone will still function normally when the external microphone is disconnected.

MENU (“SET”) MODE

13 [EMRG]

Function: Emergency channel On/Off

Available Values: on/oFF

Default Setting: on

This controls the operation of the Emergency [121.5] key. When set to “oFF,” this key will not function. You can still use the frequency 121.5 MHz either by entering it on the keypad in the VFO mode, or by recalling it on a previously-stored memory channel.

14 [TEMP]

Function: Correcting the Thermometer setting

Available Values: -12.7 ~ +12.7 °C

Default Setting: 0 °C

This allows you to calibrate the internal thermometer with a known-to-be-accurate source.

15 [BARO]

Function: Correcting the atmospheric pressure

Available Values: -127 ~ +127 hpa

Default Setting: 0 hpa

This allows you to calibrate the Barometer in the optional SU-1 Sensor Unit with a known-to-be-accurate source.

INSTALLATION OF THE SU-1

1. Make sure that the transceiver is off. Remove the hard or soft case, if used.
2. Remove the two screws affixing the belt clip and remove the belt clip, then remove the battery pack.
3. Locate the connector for the **SU-1** under the “Caution” label in the battery compartment on the back of the radio, just carefully peel off the “Caution” label.
4. Remove the small Rubber Cushion from the “Caution” label. Keep this Rubber Cushion for future use, because this Rubber Cushion must be replaced on the connector board of the transceiver if you remove the **SU-1** from the transceiver. We recommend that this Rubber Cushion be put on the bottom of the **SU-1**.
5. Align the connector on the **SU-1** with the transceiver’s connector and gently press the unit into place.
6. Affix the “Caution” label, and replace the battery and the belt clip.
7. Installation is now complete.

Important Note

The Barometric pressure/Altitude feature of the optional **SU-1** are designed to be supplemental aids for the information of the user, and are not intended to be a substitute for accurate, calibrated Barometer or Altimeter devices used for navigation critical to personal safety.

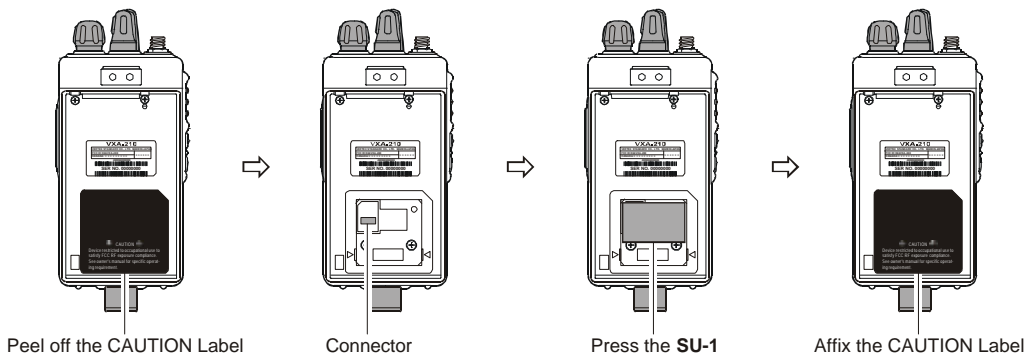

ACCESSORIES & OPTIONS

Supplied Accessories

Ni-Cd Battery Pack (7.2V, 700mAh)	FNB-64
Overnight Desktop Charger	NC-77B/C/U*
Helical Antenna	ATV-7
Headset Cable	CT-60
Operating Manual	
Warranty Card	

※: “**B**” suffix is for use with 120 VAC,
“**C**” suffix is for use with 230-240 VAC, or
“**U**” suffix is for use with 230 VAC.

Available Options

MH-44A4B	Speaker Microphone
FNB-V57	Ni-Cd Battery Pack (7.2V, 1100mAh)
FBA-25	Alkaline Battery Case
VAC-800	Desktop Rapid Charger
E-DC-5B	External Power Cable
SU-1	Barometric Pressure Sensor Unit
CN-3	Antenna Adapter (SMA to BNC)

Availability of accessories may vary. Some accessories are supplied as standard per local requirements, while others may be unavailable in some regions. Consult your Vertex Standard Dealer for details regarding these and any newly-available options.

Connection of any non-Vertex Standard-approved accessory, should it cause damage, may void the Limited Warranty on this apparatus.

ACCESSORIES & OPTIONS

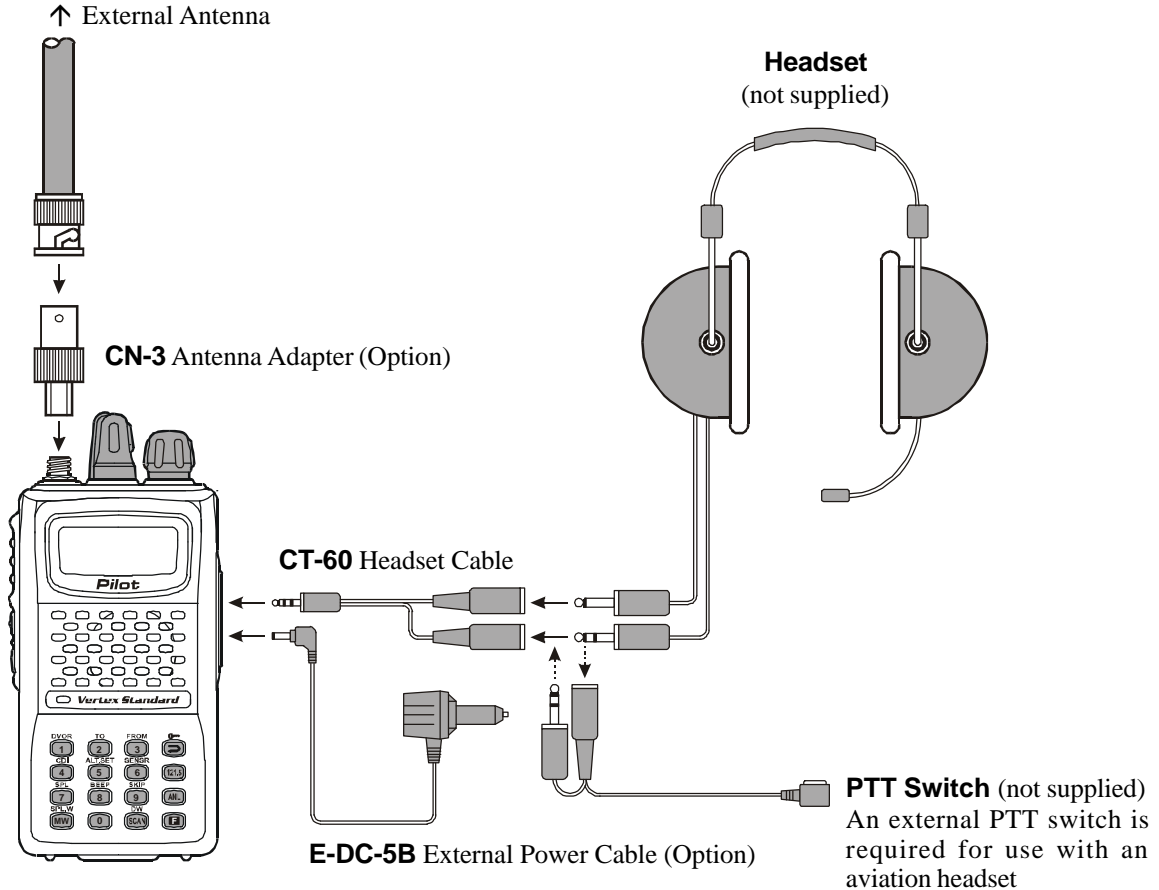

SPECIFICATIONS

General

Frequency Range:	TX: 118.000 - 136.975 MHz, RX: 108.000 - 136.975 MHz, Weather Channels (WX-01 - WX-10: USA version only)
Channel Spacing:	25 kHz
Emission Type:	TX: AM, RX: AM & FM (FM: for receiving the Weather Channels, USA version only)
Supply Voltage:	6.0 - 15.0 VDC
Current Consumption (approx.):	10 μ A (power off), 30 mA (battery saver on, saver ratio 1:5) 65 mA (squelch on), 190 mA (receive), 1 A (transmit 1.5 W Carrier)
Temperature Range:	+14 °F to + 140 °F (-10 °C to +60 °C)
Case Size (WxHxD):	2.3 x 4.3 x 1.2 inch (58 x 109 x 30 mm) w/FNB-64
Weight (approx.):	12.2 oz (345 grams) with FNB-64, antenna, and belt clip

Receiver

Circuit Type:	Double-conversion superheterodyne
IFs:	35.4 MHz & 450 kHz
Sensitivity:	<0.8 μ V (for 6 dB S/N with 1 kHz, 30 % modulation)
Selectivity:	>8 kHz/-6 dB
Adjacent CH. Selectivity:	<25 kHz/-60 dB
AF Output (@7.2 V):	0.4 W @ 8 Ohms, 10 % THD

Transmitter

Power Output (@ 7.2 V):	5 W (PEP), 1.5 W (Carrier Power)
Frequency Stability:	Better than \pm 10 ppm (+14 °F to + 140 °F [-10 °C to +60 °C])
Modulation System:	Low Level Amplitude Modulation
Spurious Emission:	>60 dB below carrier
Int. Microphone Type:	Condenser
Ext. Mic. Impedance:	150 Ohms

Specifications are subject to change without notice or obligation.

IN CASE OF DIFFICULTY

Most operational difficulties can be solved by your Vertex Avionics dealer. Please contact your dealer first for advice and assistance.

If the dealer is unable to assist you, you may contact us at Vertex Standard USA. We can be reached by telephone at (562) 404-2700 (ask the operator for Avionics Product Support).

If your radio requires repair, it must be sent to Vertex Standard USA. Please note the following:

- A Return Authorization is NOT required for repairs, either in or out of warranty. There is no need to contact us before sending a radio for repair.
- Please enclose a note describing the problem(s) with the radio, your name and shipping address (no P.O. Box numbers), and a telephone number at which we can reach you during business hours.
- Please also enclose a copy of your purchase receipt to establish the warranty date. Radio mainframes are warranted for three years. Accessory

items (batteries, antennas, chargers, etc.) are warranted for one year.

- Repair turnaround averages about 7 to 10 working days in our shop, excluding time in shipping. This time will vary, based on our current workload.
- We can provide repair estimates upon your request. There is no additional charge for the estimate if you authorize the repair. If you decline the repair after requesting an estimate, an estimate fee equal to our current schedule for 1/2 hour of labor will be charged.
- We return ship warranty repairs via UPS ORANGE (“3 Day Select”) service at our expense. Non-warranty repairs are returned via UPS BROWN (ground service) at your expense.
- The above information applies to repair procedures in the United States and Canada only. If you are in any other country, please contact your dealer for specific information and instructions.

This device complies with Part 15 of the FCC rules.
Operation is subject to the condition that this device
does not cause harmful interference.



VERTEX STANDARD CO., LTD.

4-8-8 Nakameguro, Meguro-Ku, Tokyo 153-8644, Japan

VERTEX STANDARD

US Headquarters

17210 Edwards Rd., Cerritos, CA 90703, U.S.A.

International Division

8350 N.W. 52nd Terrace, Suite 201, Miami, FL 33166, U.S.A.

YAESU EUROPE B.V.

P.O. Box 75525, 1118 ZN Schiphol, The Netherlands

YAESU UK LTD.

Unit 12, Sun Valley Business Park, Winnall Close
Winchester, Hampshire, SO23 0LB, U.K.

VERTEX STANDARD HK LTD.

Unit 5, 20/F., Seaview Centre, 139-141 Hoi Bun Road,
Kwun Tong, Kowloon, Hong Kong

Copyright 2001

VERTEX STANDARD CO., LTD.

All rights reserved.

No portion of this manual may be
reproduced without the permission of
VERTEX STANDARD CO., LTD.

Printed in Japan

0112A-0K

